

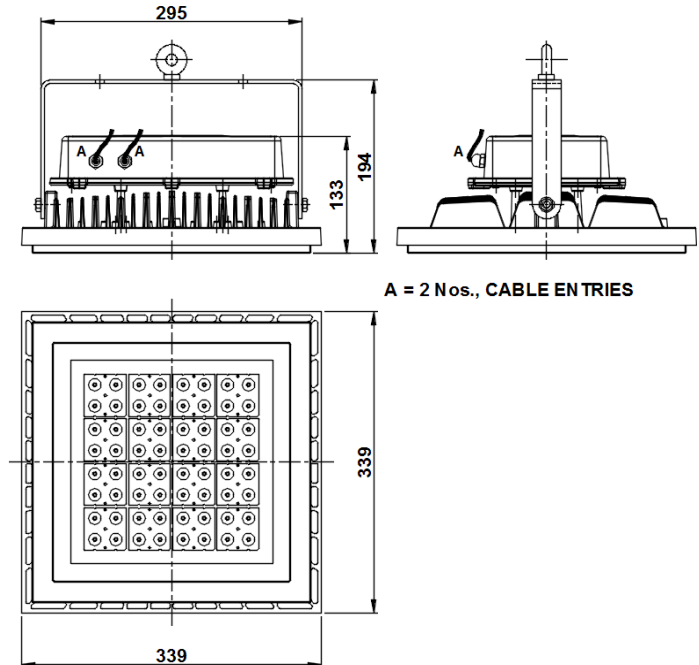

LED INDUSTRIAL LIGHTING
"RAYS"

BAJAJ BGPPH 120W LED

120W LED Highbay Luminaire



A = 2 Nos., CABLE ENTRIES

NOMINAL DIMENSIONS IN mm Tolerance +/-5mm

Application

- Airport hangers and warehouses, Heavy engineering industries,
- Thermal power stations, Railway concourse halls, Steel plants, etc.

Specification

- Powder coated pressure die-cast aluminium housing and LED driver compartment.
- LED PCB fixed on pressure die-cast aluminum housing for thermal management.
- LED Colour Temp. from 5700K
- Optics: Secondary lens optics provided.
- In addition to built-in 5kV surge protection in constant current driver, it is equipped with 10kV external surge protection.
- Input voltage range: 150–270V AC.
- Luminaire is provided with a mounting bracket fixed on pressure die-cast aluminium housing for aiming adjustment.
- Ingress Protection: IP65

Electrical Data

Product Code	Cat. Ref.	Nominal Voltage (V) AC	System Wattage (W)	Mains Current in Amps. At 240V AC	Power Factor
169878	BGPPH 120W LED	240	120W	0.590	> 0.95

Data subject to variation due to change/improvement in the design, materials and processes.

<p>BAJAJ LUMINAIRES Making the difference</p>	DRAWN	KPM	28-07-2016	FOR –
	CHECKED	SD		REV - 0 DATE-06-02-2017
	APPROVED	DVRS		DRG. No
	DATA SHEET RELEASED ON :			BGPPH 120W LED - 001
BAJAJ ELECTRICALS LIMITED 15/17, SANT SAVTA MARG, REAY ROAD, MUMBAI-400 010.				* E-mail : luminaires@bajajelectricals.com