



PENDENT/SURFACE MOUNTED LED LUMINAIRES

"AMERIS"

BXTAP 30W LED WH

PENDENT/SURFACE MOUNTED LED LUMINAIRE

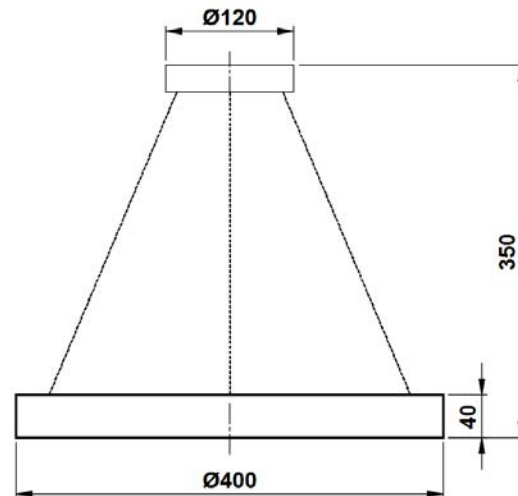

NOMINAL DIMENSIONS IN mm Tolerance +/-5

Application

Pendent/Surface mounting LED luminaire suitable for interior illumination of:

- Commercial complexes,
- Airport lounges, computer centers,
- Banks, Hospitals, Conference halls,
- Design offices, etc.

Specification

- Circular die-cast aluminium housing comprising of LED's.
- Opal diffuser fixed in aluminium housing.
- Luminaire is available with color temperature: White (WH) : 5700K \pm 300K
- Suitable for pendent mounting: Through three-rope wire suspension, luminaire is also suitable for surface mounting through mounting bracket.
- Driver: Constant current output driver, operating range 150–265V AC supply voltages.
- Finish: White powder coated.

Electrical Data

Product Code	Cat. Ref.	Nominal Voltage (V)	System Wattage (W)	Mains Current in Amps. At 240 V	Power Factor
112810	BXTAP 30W LED WH	240	30W	0.138	0.9

Data subject to variation due to change/improvement in the design, materials and processes.

 BAJAJ LUMINAIRES <i>Making the difference</i>	DRAWN	KPM	26-12-2016	FOR –
	CHECKED	AS		REV - 1 DATE-23-11-2017
	APPROVED	DVRS		DRG. No
	DATA SHEET NOT RELEASED			BXTAP 30W LED WH - 001

BAJAJ ELECTRICALS LIMITED LUMINAIRES BU, 601, RUSTOMJEE ASPIREE, SION, MUMBAI-400 022.

* E-mail : luminaires@bajajelectricals.com