



**AREA LIGHTING**  
**"TurboLED"**  
**BARFEG 160W LED**

**Rectangular Integral 160W LED Floodlight**



Pressure Die-cast Alu. Cover holding extruded Alu. Heat sink

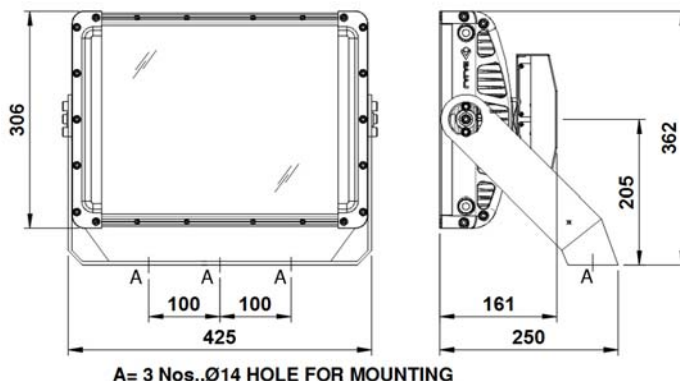

Nominal dimensions in mm Tolerance +/-5 (Except mtg. Hole)

**Application**

- Lighting of small to medium size bill boards,
- Parking areas around the residences, building complexes and colonies,
- Security lighting,
- General area lighting,
- Lighting of monuments, etc.

**Specification**

- Extruded aluminium heat sink, designed to act as efficient heat dissipater – important for LED luminaires.
- Pressure die-cast aluminium cover on both sides for holding of extruded aluminium heat sink.
- Luminaire provided with heat resistant toughened glass.
- Control gear compartment is an integral part of luminaire.
- LED specification – Make – CREE LED / Equivalent.  
 Colour Temp. - 5700K ±300K
- LEDs are provided with secondary lens optics to get optimum optical performance.
- The driver used is specially designed to have surge voltage, open/short circuit protections.
- Luminaire is provided with a mounting bracket fixed on pressure die-cast aluminium covers for aiming adjustment.
- Degree of protection - IP66

**Electrical Data**

Product Code	Cat. Ref.	Nominal Voltage (V)	System Wattage (W)	System Current In Amps. At 240V AC	Power Factor
169642	BARFEG 160W LED	240	160	0.705	> 0.95

Data subject to variation due to change/improvement in the design, materials and processes.

<p><b>BAJAJ LUMINAIRES</b>                  Making the difference</p>	DRAWN	KPM	25-07-2015	FOR –
	CHECKED	SP		REV - 1 DATE-01-06-2016
	APPROVED	DVRS		DRG. No
	DATA SHEET RELEASED ON DT-			<b>BARFEG 160W LED – 001</b>
<b>BAJAJ ELECTRICALS LIMITED</b> 15/17, SANT SAVTA MARG, REAY ROAD, MUMBAI-400 010.				* E-mail : <a href="mailto:luminaires@bajajelectricals.com">luminaires@bajajelectricals.com</a>