



Brilliance beyond illumination

COMMERCIAL LIGHTING



More than
10000
Workspaces Litup

More than
50000
Connected Points

More than
5 MILLION
Office Light Points

9
Decades
of legacy

 Inhouse R&D
Facilities
along with
Manufacturing
Facilities

 Concept
to
Care

LIGHTING FOR PEOPLE, NOT JUST FOR WORKSPACE!

Lighting plays a crucial role in enhancing employee comfort and productivity at the workspace. It's not just about illuminating spaces; it's about creating environments where people feel energized, motivated, and focused at work.

Employee well-being is of prime importance for the employer. Our innovative designs create productive and safe spaces by reducing eye strain, improving mood, and supporting overall health. We also prioritize sustainable solutions, ensuring that your workspace is both efficient and environmentally friendly. With an emphasis on aesthetics, Bajaj not only illuminates a space but also empowers people to thrive in an inspiring environment.



ENHANCED WELLNESS

Employee well-being at workspaces is crucial for productivity and self-satisfaction. A thoughtful workspace architecture can enhance physical comfort, mental health, and a supportive environment leads to reduced stress and increased motivation. Prioritizing well-being fosters a positive culture, enhancing overall performance and commitment to employees' success.

FOSTER PRODUCTIVITY & SAFETY

Workspaces should complement and facilitate employee productivity by creating an environment that minimizes fatigue and enhances focus. A well-designed workspace promotes safety through ergonomic setups, proper lighting, and thoughtful layouts, ensuring employees feel secure and comfortable. This balance fosters higher efficiency, satisfaction, and overall well-being, leading to better employee performance.



MAXIMISE SUSTAINABLE

Sustainability in workspace facilities, driven by thoughtful management choices, supports long-term environmental and economic goals. Implementing energy-efficient systems, reducing waste, and using sustainable materials not only lowers operational costs but also enhances corporate responsibility. These practices contribute to better organizational performance and align with broader sustainability objectives.

EXQUISITE AESTHETICS

Utilities in the workspace should align with modern trends to create a vibrant, welcoming environment. Contemporary designs and technologies make spaces more collaborative and inviting, enhancing employee satisfaction and productivity. By incorporating up-to-date features, workspaces become more engaging and supportive, nurturing a positive atmosphere and encouraging teamwork.





OUR DESIGN PHILOSOPHY



Light Embracing
Comfort



Sustainability
Meets Style



Personalised
Solutions



Smart And
Future Ready



Energy
Efficient

SMART & CONNECTED LIGHTING SOLUTION



smart



emotional



visual

SYSTEM ARCHITECTURE

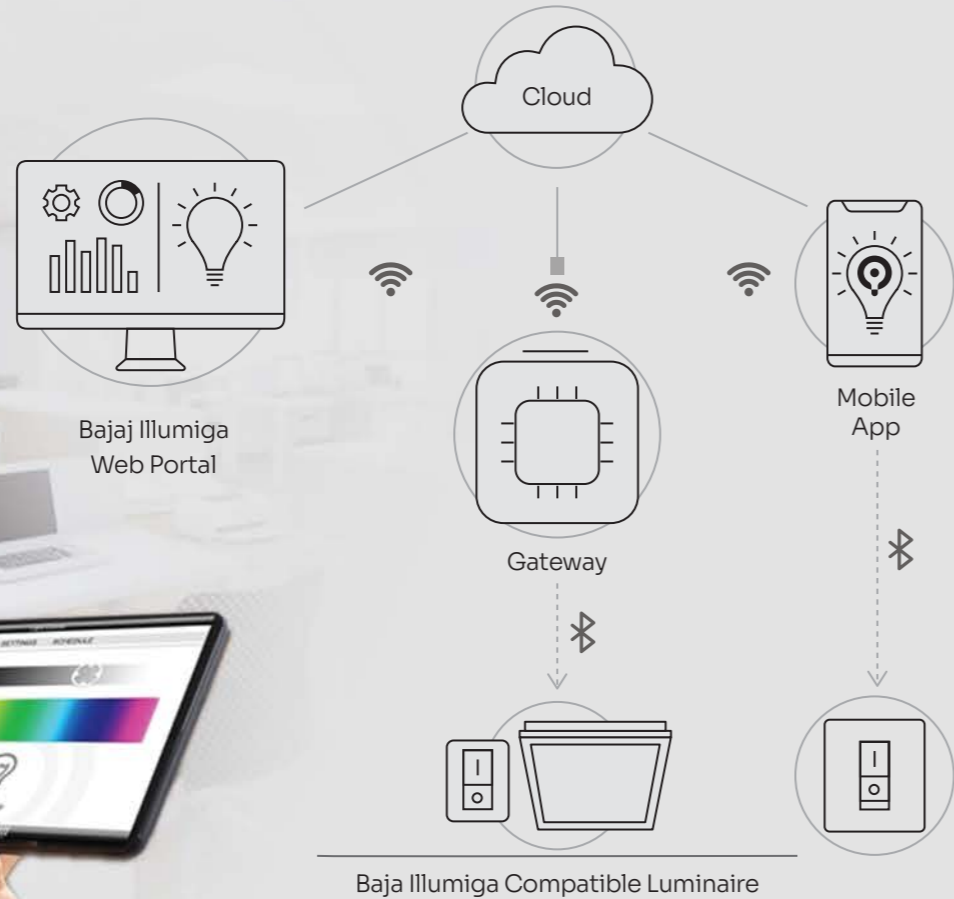

INSTALL IN A SNAP!

PLANNING



Design
Create a network plan and devise a lighting layout.

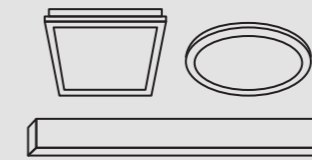

Select luminaires
Bajaj Illumiga enabled

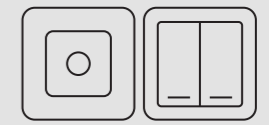
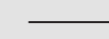

Customize your lighting system
Pair your setup with compatible sensors and switches.

SETUP



Install like usual gadgets



Download and install the mobile app



Get ready using the web app or mobile app



Setup using the mobile app



Add gateways for remotely managing the site on your web-app

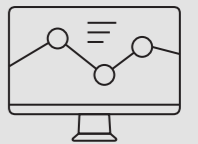

Manage and monitor using the mobile and web app



Smart & Connected Lighting Solutions



Presence Detection

Activates lights only when motion is detected, saving energy.



Daylight Harvesting

Automatically dims lights based on available natural lights.



Wireless Controls

Enable easy lighting control from anywhere.



Scene Scheduler

Create and recall custom scenes effortlessly using wireless switches or an app.



Remote Monitoring & Control

Monitor device lifetimes, potential failures, and burning hours for improved building upkeep.



Energy Usage Analysis

Access detailed energy consumption reports to further analyze and optimize your building's energy saving plan.



Automatic Upgrades

Seamlessly receive background updates for features and security with minimal disruption to building operations.



Predictive Maintenance

Be alerted with unusual system behaviour for proactive and preventive maintenance.



Human Centric Light. You centric light.

We at Bajaj have engineered lighting solutions that attempt to achieve a perfect synchrony of brain, soul, and light helping users to maintain their circadian rhythm. Bajaj Illumiga's Human Centric Lighting Solutions provide adaptive, versatile and intelligent lighting systems that can illuminate everything from workspaces to healthcare facilities and educational spaces.

However varied your needs may be, Bajaj Illumiga's Human Centric Lighting (HCL) Solutions consistently provide a 'user-centric' lighting experience. Our HCL technology adjusts its light profiles throughout the day to adapt to the surroundings and match the natural lighting outside. This creates an environment that reproduces naturally lit settings as closely as possible, thus improving user wellbeing, welfare and productivity.



Visual

It makes for a comfortable and relaxing environment, thus influencing the way one works.



Emotional

By virtue of following a circadian cycle, this light affects one's mood, well-being and even perception of space.



Biological

It adapts to the required lighting according to the time of the day, helping the user to perform better at work, manage day-to-day activities and complete tasks effectively.



VISUAL COMFORT

Embracing Wellness

Bajaj Visual comfort lighting solutions emphasis on the need of having quality lighting at workspace areas for reducing eye strain and enhancing focus. Well-designed lighting ensures adequate illumination without glare, creating a comfortable environment that supports productivity.

By prioritizing visual comfort, workspaces become more inviting, allowing employees to work efficiently and with improved well-being.



CRI >90
Enhances vision

Improves concentration, and fosters a more comfortable and pleasing environment.



R9 >70
Improved Visual Appeal

Ideal combination of Blue & Red in the spectrum facilitates high focused working.



UGR <19
Glare Reduction

Ensuring complete glare free lighting at your workplace.



Ripple <5%
Flicker Free

Eliminates stroboscopic effect, enhancing user comfort for reading and work.



Upto 130lm/W
Best-in-class Efficacy

Visual comfort with unmatched efficacy.



**DISCOVER THE RANGE
OF COMMERCIAL
LIGHTING LUMINAIRES**

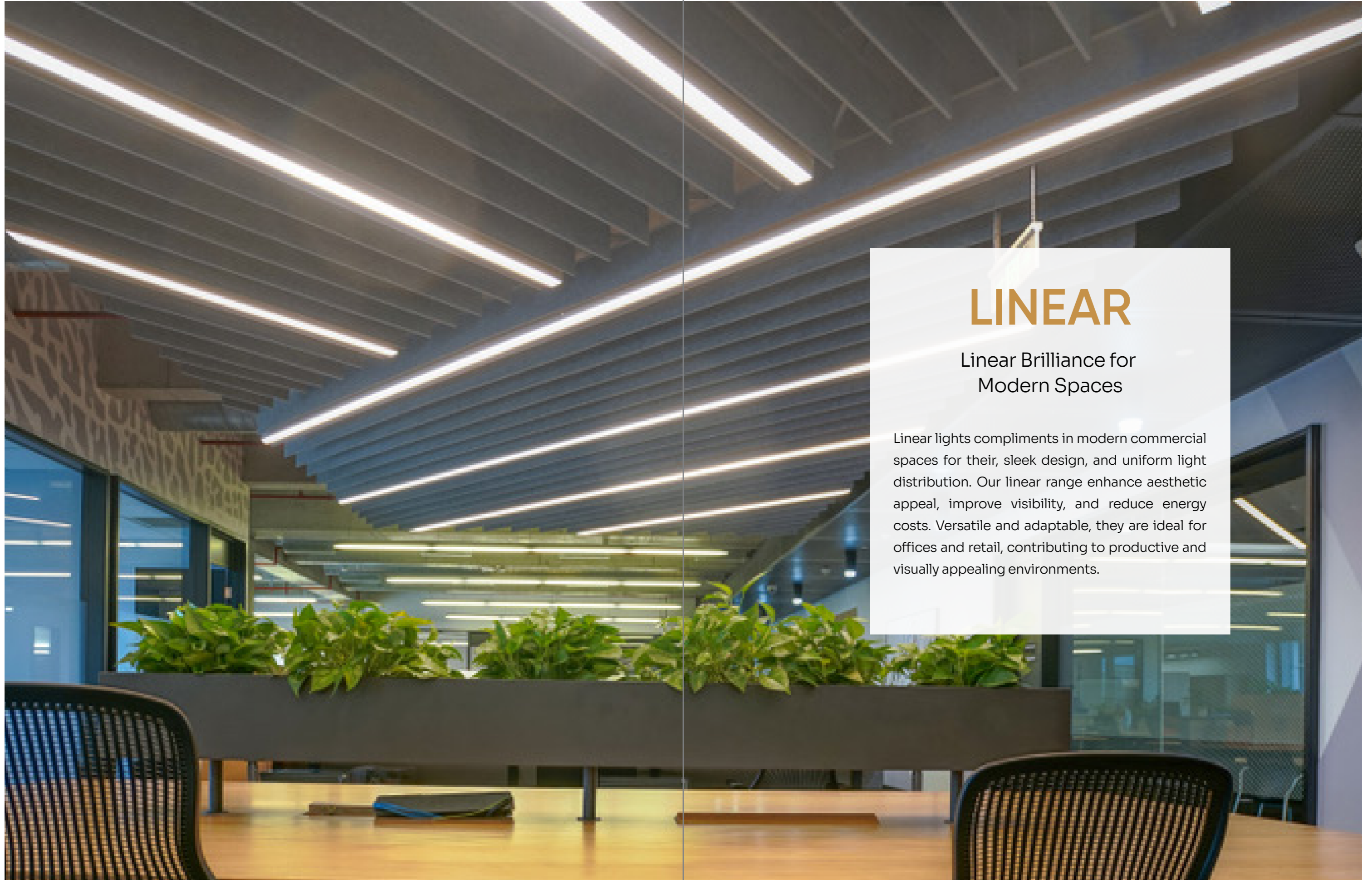

LINEAR

Linear Brilliance for Modern Spaces

Linear lights compliments in modern commercial spaces for their, sleek design, and uniform light distribution. Our linear range enhance aesthetic appeal, improve visibility, and reduce energy costs. Versatile and adaptable, they are ideal for offices and retail, contributing to productive and visually appealing environments.

LEVITAIRE

Recess Linear Luminaire

Illuminate with style

Transform your space with our Linear Recessed standalone and continuous luminaire, where sleek aesthetics meet unparalleled efficacy. Enjoy stunning design and exceptional efficiency in every corner, perfectly balancing style with sustainability.



Superior & appealing Aesthetics
White Powder coated aluminium extrusion housing



High Efficacy
Upto 100 lm/W



Continuous line of light
End to End connectivity and wire harness for loop in-loop out available



>0.95
Power Factor



>80
CRI



<10%
THD (@240V AC)



Applications



Offices



Banks



Hospitals

Product Diagram



Specifications & Dimensions

Wattage	Cat ref	Efficacy (lm/W)	CCT (K)	Dimensions (mm)		
				A	B	C
20W	BRCS 20W LED WH 4F	100	5700	1200	65	50
28W	BRCS 28W LED WH 4F	100	5700	1200	65	50
40W	BRCS 40W LED WH 4F	100	5700	1200	65	50
40W	BRCS 40W LED WH 8F	100	5700	2400	65	50
56W	BRCS 56W LED WH 8F	100	5700	2400	65	50
80W	BRCS 80W LED WH 8F	100	5700	2400	65	50

Options available -

- CCTs: Warm White, Neutral White, Cool White
- Dimming



LEVITAIRE

Linear Suspended Luminaire

Sleek and Stylish

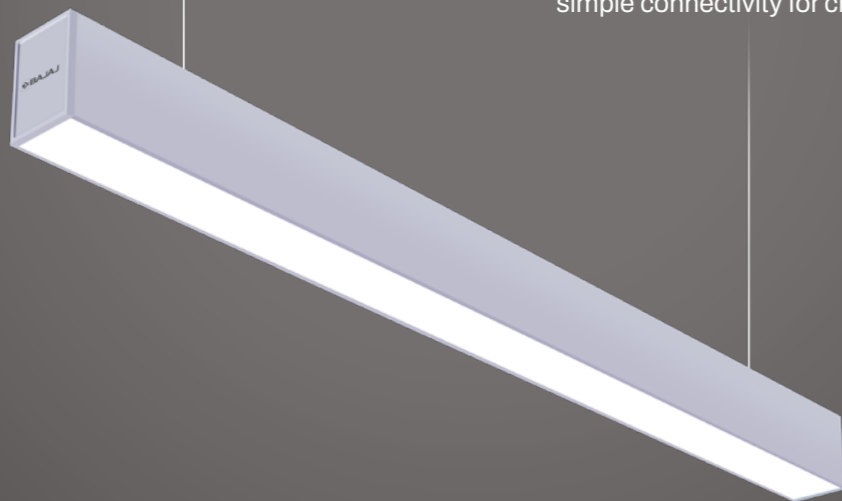
Introducing Levitaire standalone & connect linear suspended luminaires, designed for workstations to provide sleek, aesthetically pleasing lighting solutions. Ideal for modern offices, they enhance productivity and workplace ambiance effortlessly. Ideal for offices, they offer easy installation and simple connectivity for creating a continuous series of lights.

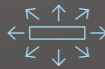

- 
Superior & appealing Aesthetics
 White Powder coated aluminium extrusion housing
- 
High Efficacy
 Upto 100 lm/W
- 
Continuous line of light
 End to End connectivity and wire harness for loop in-loop out available
- 
Ease of Installation
 Provided with suitable suspensions for easy installation.

Applications

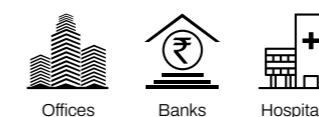

Product Diagram

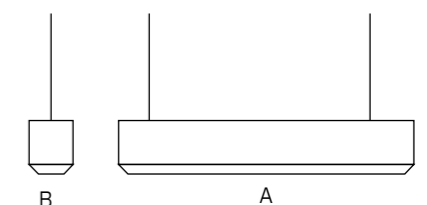

Specifications & Dimensions

Wattage	Cat ref	Efficacy (lm/W)	CCT (K)	Dimensions (mm)		
				A	B	C
20W	BPCS 20W LED WH 4F	100	5700	1200	52	75
28W	BPCS 28W LED WH 4F	100	5700	1200	52	75
40W	BPCS 40W LED WH 4F	100	5700	1200	52	75
40W	BPCS 40W LED WH 8F	100	5700	2400	52	75
56W	BPCS 56W LED WH 8F	100	5700	2400	52	75
80W	BPCS 80W LED WH 8F	100	5700	2400	52	75
20W	BPCS 20W LED WH 4F CT	120	5700	1200	52	75
28W	BPCS 28W LED WH 4F CT	120	5700	1200	52	75
40W	BPCS 40W LED WH 4F CT	120	5700	1200	52	75

Options available -

- CCTs: Warm White, Neutral White, Cool White
- Housing Color: Black
- Dimming
- Continuous line of light

Options for direct indirect lighting

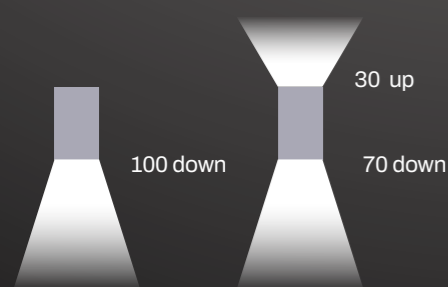

- 
>0.95
 Power Factor
- 
>80
 CRI
- 
<10%
 THD (@240V AC)

LEVITAIRE

Regressed Linear Luminaire

Suspended brilliance, minimal glare

Elevate workspace tranquility with our suspended linear lights. Regressed diffusers minimize glare, fostering focused productivity in an ambiance of refined elegance



Superior & appealing Aesthetics

White Powder coated aluminium extrusion housing



Soft Glow, Less Glare

Deep regressed diffuser to ensure UGR <19



Continuous line of light

End to End connectivity and wire harness for loop in-loop out available

Options for direct indirect lighting

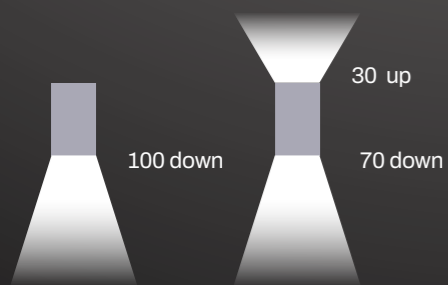

>0.95
Power Factor

>80
CRI

<10%
THD (@240V AC)



Applications



Offices



Banks



Hospitals

Product Diagram

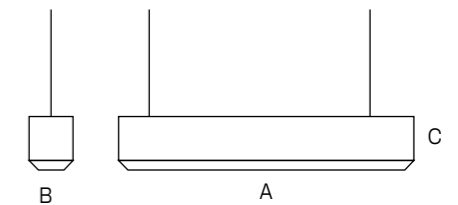

Specifications & Dimensions

Wattage	Cat ref	Efficacy (lm/W)	CCT (K)	Dimensions (mm)		
				A	B	C
40W	BPCS DR 40W LED WH 4F	85	5700	1200	55	85

Options available -

- CCTs: Warm White, Neutral White, Cool White | Up-down | Housing Color: Black • Dimming

LEVITAIRE

Linear Suspended Luminaire

Elevate ambiance, minimize glare

Elevate your ambiance and minimize glare with our range of sophisticated lighting solutions. Illuminate your world with elegance, where style meets functionality in every beam.

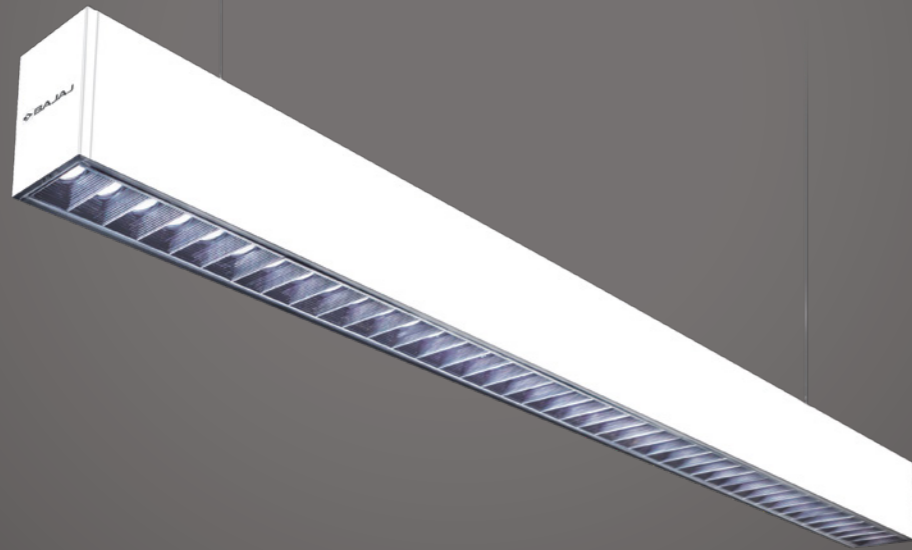

Superior & appealing aesthetics
Black powder coated aluminium extrusion housing



Soft Glow, Less Glare
Special designed lens to ensure UGR <10



Continuous line of light
End to End connectivity and wire harness for loop in-loop out available

Options for direct indirect lighting

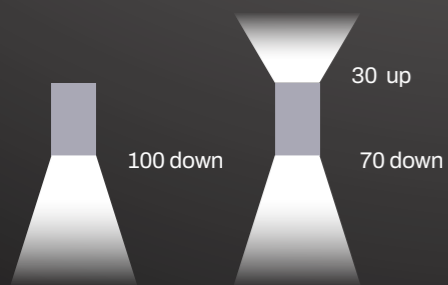

>0.95
Power Factor

>80
CRI

<10%
THD (@240V AC)



Applications



Offices



Banks



Hospitals

Product Diagram

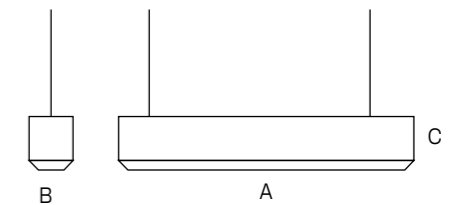

Specifications & Dimensions

Wattage	Cat ref	Efficacy (lm/W)	CCT (K)	Dimensions (mm)		
				A	B	C
28W	BPCS LZ 28W LED WH 4F	100	5700	1126	40	82

Options available -

- CCTs: Warm White, Neutral White, Cool White | Up-down | Housing Color: Black • Dimming

LEVITAIRE

Formations Connector Options

Specifications & Dimensions

Wattage	Cat ref	Dimensions (mm)		
		A	B	C
56W	BPCS 56W LED WH X2F	605	52	75
40W	BPCS 40W LED WH Y2F	605	52	75
28W	BPCS 28W LED WH L2F	605	52	75

*Suitable for CT housing only

Options available -

- CCTs: Warm White, Neutral White, Cool White
- Housing Colour - Black

Y CONNECTOR

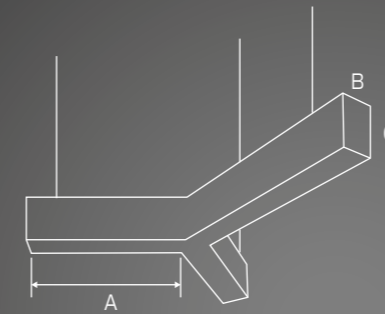
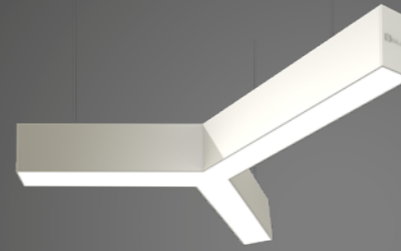

+ CONNECTOR

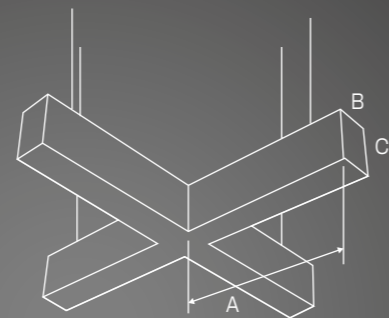

L CONNECTOR

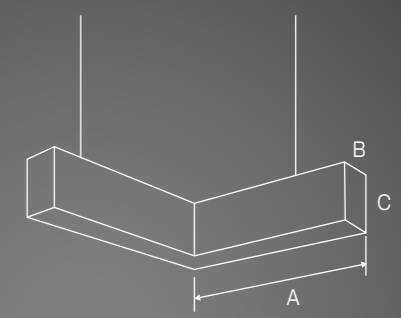
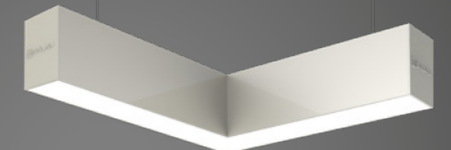





TROFFER

Enhancing Productivity
and Comfort in
Commercial Office Spaces

LED troffers offer a contemporary solution, providing superior illumination while reducing energy consumption. Designed to fit seamlessly into office ceilings, LED troffers deliver consistent and glare-free lighting, creating an optimal environment for work tasks and enhancing employee well-being.

SKYLUX

2x2 Luminaires

Built Tough, Shining Bright

Bajaj Skylux range is an aesthetically designed fabricated CRCA housing making it sturdy and energy efficient illumination.



Superior & appealing Aesthetics

CRCA white powder coated housing, having better aesthetic finish



Best in Class System Efficacy

upto >120 lumens per watt



Glare free uniform illumination

high performance diffuser ensures glare



Long life

50000 LED burning hours



>0.95
Power Factor



>80
CRI



<10%
THD (@240V AC)

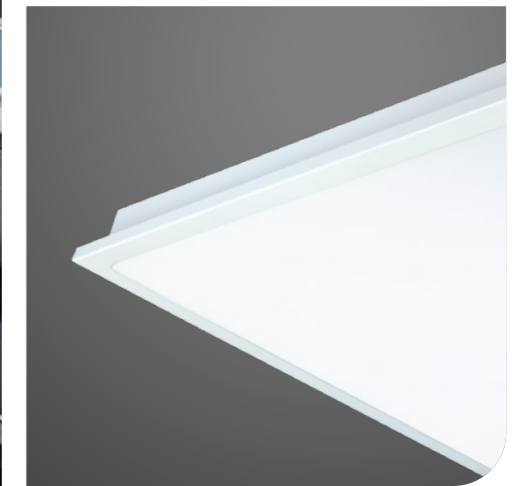

Applications



Offices



Banks



Hospitals



Educational
Facilities

Product Diagram

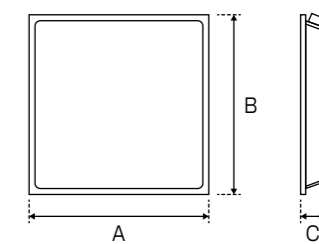

Specifications & Dimensions

Wattage	Cat ref	Efficacy (lm/W)	CCT (K)	Dimensions (mm)		
				A	B	C
24W	BZRSQL 30L XE WH OD SD	120	5700	595	595	75
30W	BZRSQL 36L XE WH OD SD	120	5700	595	595	75
36W	BZRSQL 43L XE WH OD SD	120	5700	595	595	75

Options available -

- CCTs: Warm White, Neutral White, Cool White
- Surface Mounting
- Dimming

SKYLUX GLADDEN

2x2 Luminaires

Sleek & Seamless

Bajaj Gladden series is reliable, energy efficient, sleek & light weight range of troffers. Range is exquisitely designed to deliver high system lumen efficacy.

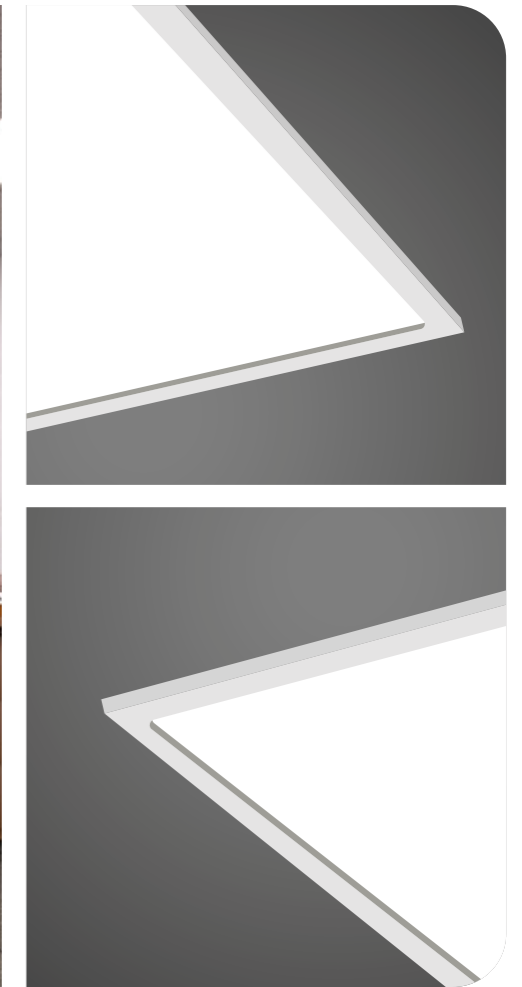

Superior & appealing Aesthetics

CRCA white powder coated housing, having better aesthetic finish



Energy Efficient

with upto 120 lumens per watt



Mounting Flexibility

Suitable for all kind ceilings



High Performance Diffuser

Uniformly lit special diffuser with well distributed light.



>0.90
Power Factor



>80
CRI



<20%
THD

Applications



Offices



Banks



Hospitals



Educational
Facilities

Product Diagram

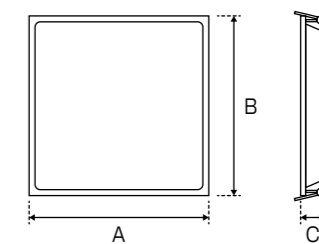

Specifications & Dimensions

Wattage	Cat ref	Efficacy (lm/W)	CCT (K)	Dimensions (mm)		
				A	B	C
24W	BZRSQL 30L LED GX Pro	120	5700	595	595	31
30W	BZRSQL 36L LED GX Pro	120	5700	595	595	31
36W	BZRSQL 43L LED GX Pro	120	5700	595	595	31
30W	BZRSQL 30L LED GX	100	5700	595	595	31
36W	BZRSQL 36L LED GX	100	5700	595	595	31
42W	BZRSQL 42L LED GX	100	5700	595	595	31
30W	BZRSQL 30W LED WH XT	100	5700	595	595	31
36W	BZRSQL 36W LED WH XT	100	5700	595	595	31

Options available -

- CCTs: Warm White, Neutral White, Cool White
- Dimming
- 1x4 and 1x1
- Surface mounting

SKYLUX PIR

2x2 Luminaires

Presence-Powered Lighting

This range features an integrated PIR sensor, ideal for modern workspaces, assembly halls, and other commercial spaces where sensor-based on/off functionality is essential, ensuring enhanced energy savings.



Superior & appealing Aesthetics

CRCA white powder coated housing, having better aesthetic finish



High Efficacy

with upto 100 lumens per watt



PIR Sensor

With detection range: @2.5- 4Mtr. Height, 12M for walk across motion, 360° motion detectable



High Performance Diffuser

For better light transmission and pure effect

>0.95
Power Factor

>80
CRI

<10%
THD (@240V AC)



Applications



Offices



Banks



Hospitals



Educational Facilities

Product Diagram

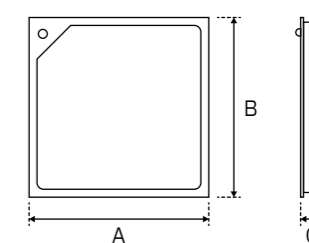

Specifications & Dimensions

Wattage	Cat ref	Efficacy (lm/W)	CCT (K)	Dimensions (mm)		
				A	B	C
30W	BZRSQL 30W GZ1 WH PIR	100	5700	595	595	75
36W	BZRSQL 36W GZ1 WH PIR	100	5700	595	595	75
43W	BZRSQL 43W GZ1 WH PIR	100	5700	595	595	75



DOWNLIGHT

Enhance Spaces with
Smart LED Downlighting

LED downlights are crucial in modern commercial spaces. Our downlight range reduce electricity costs and maintenance needs, offering a sustainable lighting solution. With advanced dimming capabilities and smart controls, our downlight range allow for customizable lighting, creating dynamic and adaptive spaces.

DOVEE i

Recessed Downlights

Effortless Elegance, Low Glare-Free Brilliance

Presenting Dovee-i, a stylish LED downlight in round and square shape that provides a more natural, soft light with deep recessed diffuser, perfect for enhancing esthetics's of contemporary commercial spaces

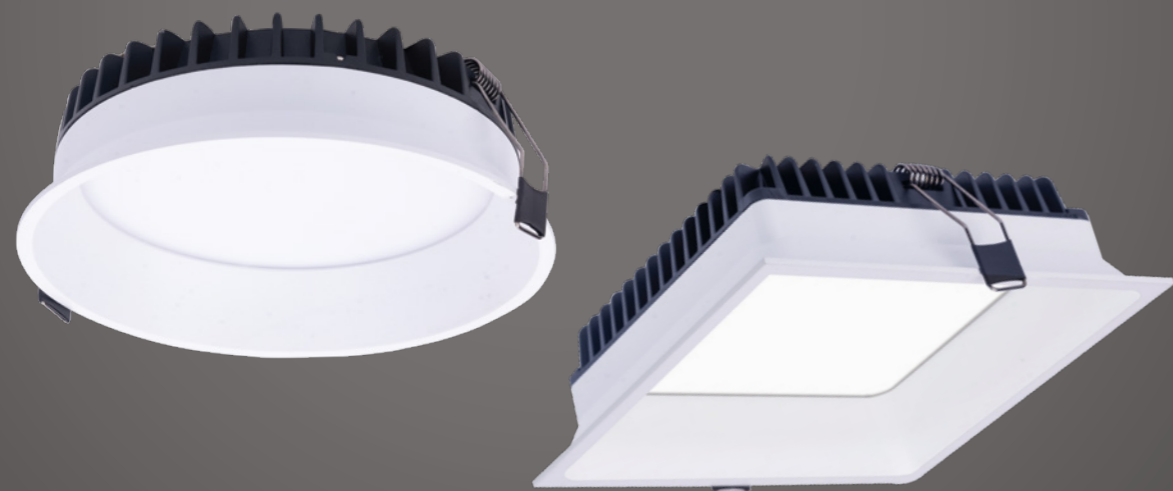

Superior & appealing aesthetics
White Powder coated aluminium die-cast housing

Low Glare
Deep Recessed diffuser to minimise glare

High Lumen efficacy
upto 100 lm/W

High Performance Driver
Highly efficient electronic driver provided with open and short circuit protection

>0.95 Power Factor **>80** CRI **<10%** THD (@240V AC)



Applications



Product Diagram

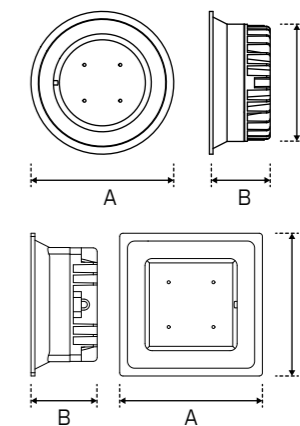

Specifications & Dimensions

Wattage	Cat ref	Efficacy (lm/W)	CCT (K)	Dimensions (mm)		
				A	B	C
12W	BZSLO .nxt 12L LED WH RD TY	100	5700	Ø120	50	110
15W	BZSLO .nxt 15L LED WH RD TY	100	5700	Ø120	50	110
18W	BZSLO .nxt 18L LED WH RD TY	100	5700	Ø150	50	140
24W	BZSLO .nxt 24L LED WH RD TY	100	5700	Ø170	50	160
12W	BZSLO .nxt 12L LED WH SQ TY	100	5700	110	50	100
15W	BZSLO .nxt 15L LED WH SQ TY	100	5700	110	50	100
18W	BZSLO .nxt 18L LED WH SQ TY	100	5700	140	50	135
24W	BZSLO .nxt 24L LED WH SQ TY	100	5700	165	50	155

DOVEE PRO

Recessed/surface mounting LED Luminaire

Energy-Efficient Downlights

Presenting Dovee-i, a stylish LED downlight in round and square shape that provides a more natural, soft light with deep recessed diffuser, perfect for enhancing esthetics's of contemporary commercial spaces



Superior & appealing aesthetics
Die cast aluminum housing

High Efficacy
Best in class system level efficacy 125 lm/W

Better ROI
Greater energy saving help users to improve ROI

Long Life
>50000 LED Burning Hours

>0.95 Power Factor **>80** CRI **<10%** THD (@240V AC)



Applications

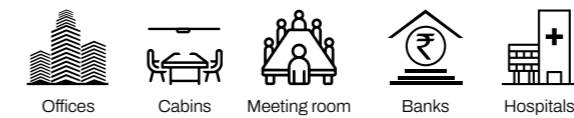

Product Diagram

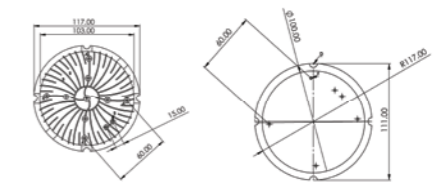

Specifications & Dimensions

Wattage	Cat ref	Efficacy (lm/W)	CCT (K)	Dimensions (mm)		
				A	B	C
12W	BZSLO PRO nxt 12W LED CW SD	125	6500	Ø148	28	120
15W	BZSLO PRO nxt 15W LED CW SD	125	6500	Ø148	28	120
18W	BZSLO PRO nxt 18W LED CW SD	125	6500	Ø168	28	140
24W	BZSLO PRO nxt 24W LED CW SD	125	6500	Ø168	28	140

Options available -

- CCTS- Warm white, Neutral White
- Surface Mounting
- Dimming

GLINT

Recessed/surface mounting LED Luminaire

Sleek by Design, Brilliant by Nature

Aesthetically designed ultra sleek downlighters with die cast aluminum housing for all kind of office application and workspace solution with high efficiency and highly efficient diffuser provides for uniform illumination and better futuristic solution.

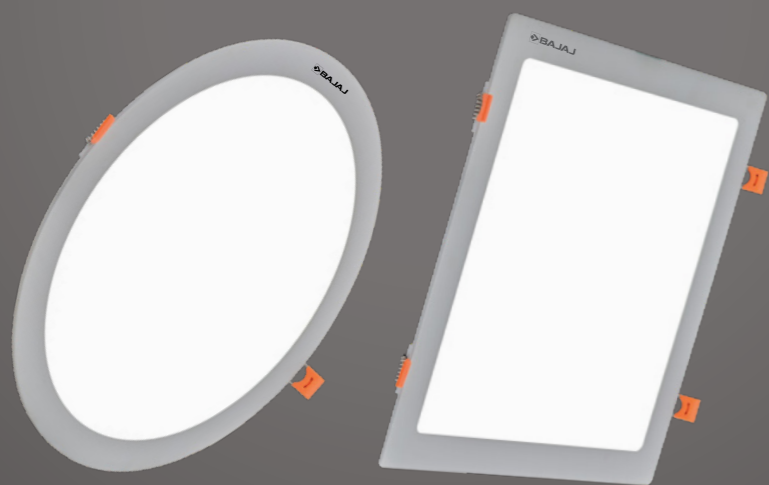

Superior & appealing aesthetics
Sleek and Slim design in die cast aluminum housing

High Lumen Efficacy
Higher wattages with High lumen LEDs for better light output.

Mounting Flexibility
Suitable for any ceiling system.

High Performance Diffuser
High performance diffuser for better light transmission and pure effect.

>0.90 Power Factor **>80** CRI **<10%** THD (@240V AC)

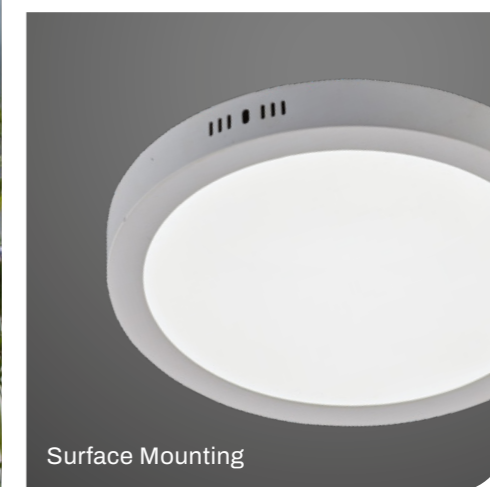

Applications

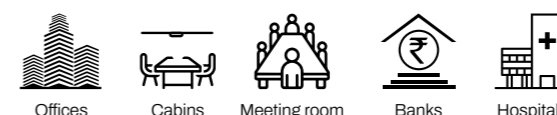

Product Diagram

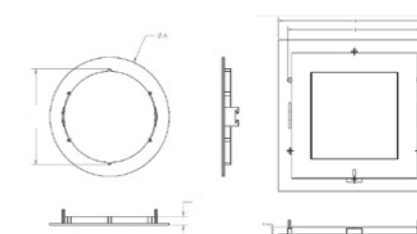

Specifications & Dimensions

Wattage	Cat ref	CCT (K)	Dimensions (mm)		
			A	B	C
9W	BGSLO Sleek Recess RD 9W WH LED	6500	Ø120	20	104
12W	BGSLO Sleek Recess RD 12W WH LED	6500	Ø172	20	153
15W	BGSLO Sleek Recess RD 15W WH LED	6500	Ø190	20	173
18W	BGSLO Sleek Recess RD 18W WH LED	6500	Ø190	20	173
9W	BGSLO Sleek Recess SQ 9W WH LED	6500	152	20	128
12W	BGSLO Sleek Recess SQ 12W WH LED	6500	170	20	153
15W	BGSLO Sleek Recess SQ 15W WH LED	6500	190	20	173
18W	BGSLO Sleek Recess SQ 18W WH LED	6500	190	20	173
24W	BGSLO Sleek Recess SQ 24W WH LED	6500	300	20	275

Options available -

- CCTS- Warm white, Neutral White
- Surface Mounting

RADIANCE

Recessed/surface mounting LED Luminaire

Slim Downlights for Modern offices

Bajaj Radiance PC Downlight, a perfect blend of style and efficiency for modern interiors. Designed with a sleek, durable polycarbonate, it delivers superior illumination with energy-saving. Radiance Downlight enhances any space with its bright, consistent light and contemporary design.



Superior & appealing aesthetics
Sleek and Slim design in polycarbonate housing

HighLumen Efficacy
Higher wattages with High lumen LEDs for better light output.

Mounting Flexibility
Suitable for any ceiling system.

High Performance Diffuser
High performance diffuser for better light transmission and pure effect.

>0.90 Power Factor **>80** CRI **<20%** THD (@240V AC)

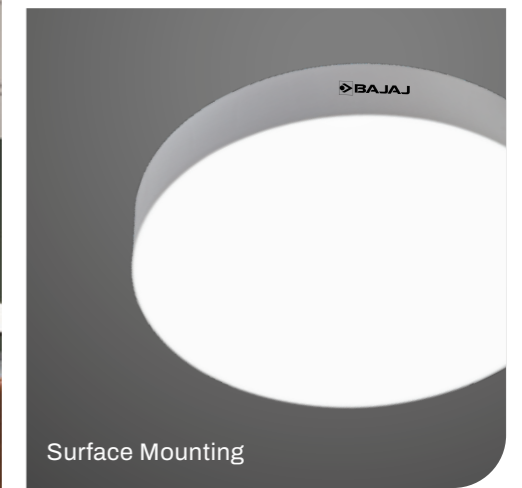

Applications

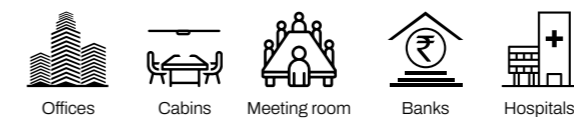

Product Diagram

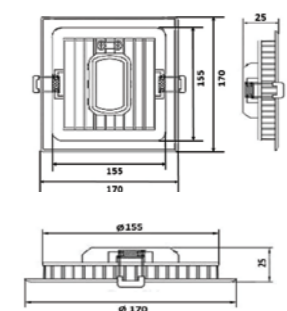

Specifications & Dimensions

Wattage	Cat ref	Efficacy (lm/W)	CCT (K)	Dimensions (mm)		
				A	B	C
9W	BPSLR 9W LED WH RD SD	100	5700	Ø170	25	155
12W	BPSLR 12W LED WH RD SD	100	5700	Ø170	25	155
15W	BPSLR 15W LED WH RD SD	100	5700	Ø170	25	155
18W	BPSLR 18W LED WH RD SD	100	5700	Ø220	25	205
9W	BPSLR 9W LED WH SQ SD	100	5700	170	25	155
12W	BPSLR 12W LED WH SQ SD	100	5700	170	25	155
15W	BPSLR 15W LED WH SQ SD	100	5700	170	25	155
18W	BPSLR 18W LED WH SQ SD	100	5700	218	25	205

Options available -

- CCTS- Warm white, Neutral White
- Surface Mounting

GLINT COB

Recessed COB Downlights

Where Style Meets Illumination

New generation COB LED technology best solution to focus light on work plane and designed to enhance the beauty of every architectural environment and create the modern, fashionable and stylish atmosphere



Superior & appealing aesthetics

Die cast aluminum housing



long Life

Best thermal management for better and long service life.



High Lumen efficacy

High lumen LEDs for better light output



Even Glow, No Harm

Ensure Uniform, natural and soft lighting without UV or IR radiation



>0.96
Power Factor



>80
CRI



<20%
THD (@240V AC)



Applications



Offices



Cabins



Meeting room



Banks



Hospitals

Product Diagram

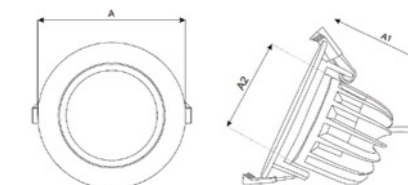

Specifications & Dimensions

Wattage	Cat ref	Efficacy (lm/W)	CCT (K)	Dimensions (mm)		
				A	B	C
7W	BRDCSL 7W CW	85	6500	Ø87	56	70
12W	BRDCSL 12W CW	85	6500	Ø100	71	85
15W	BRDCSL 15W CW	85	6500	Ø100	71	85
18W	BRDCSL 18W CW	85	6500	Ø115	72	95
24W	BRDCSL 24W CW	85	6500	Ø135	85	125

Also available 3000K and 4000K CCT • Beam Angle - 40°

CONSCIO

Pendant Mount Cylindrical COB Downlight

Modern Interiors, Modern Downlights

“Conscio” offers design simplicity for creating luxurious ambience and provides enriching experience to modern workspaces. High transmittance which makes the light uniform soft comfortable and without losing the brightness. Special optical lens with an anti-glare reflector that creates a perfect ambience in the space.



Superior & appealing aesthetics
Powder coated extruded aluminum housing with black finish

Mounting Flexibility
Suspension with power cable

High Lumen efficacy
Highly efficient and antiglare reflector optics

High Performing LEDs
COB LED for optimum light output

>0.95 Power Factor **>80** CRI **<10%** THD (@240V AC)

Applications



Product Diagram

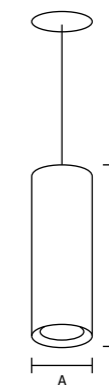

Specifications & Dimensions

Wattage	Cat ref	Efficacy (lm/W)	CCT (K)	Dimensions (mm)	
				A	B
10W	BSDCSL 10W	100	6500	Ø80	170
20W	BSDCSL 20W	100	6500	Ø80	190
30W	BSDCSL 30W	100	6500	Ø80	220

Also available 3000K and 4000K CCT



BATTEN

Energy Efficient Battens for
Brighter tomorrow

Illuminate your modern interiors with energy-efficient battens that deliver superior brightness and significant cost savings. Their sleek design and high efficacy not only enhance your space but also promote sustainability, making them the smart choice for commercial spaces.

DAWN

LED Batten

Efficiency, reliability, brilliance

Dawn is a light weight batten with high efficacy, long life span and EMI/EMC driver. The luminaire comprises of extruded aluminium housing offering superior finish, long LED burning hours and high transitivity ensuring uniform lighting.



Superior & appealing aesthetics
Extruded aluminium housing fitted with Engg. Plastic end caps.



High Efficacy
Upto 120 lm/W



Better ROI
Greater energy saving help and users to improve ROI



Long Life
>50000 LED Burning Hours



>0.95
Power Factor



>80
CRI



<20%*
THD (@240V AC)



Applications



Offices



Educational Facilities



Banks



Hospitals



Indoor Parking

Product Diagram

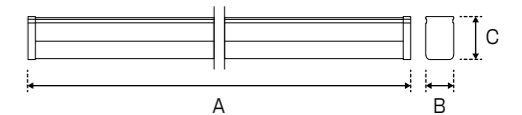

Specifications & Dimensions

Wattage	Cat ref	Efficacy (lm/W)	CCT (K)	Dimensions (mm)		
				A	B	C
20W	BCLAB 20W CW LED EM	120	6500	1185	21.5	37
40W	BCLAB 40W CW LED EM	120	6500	1185	21.5	37
20W	BCLAB 20W CW LED XT	120	6500	1185	21.5	37
40W	BCLAB 40W CW LED XT	110	6500	1185	21.5	37
10W	BCLAB 10W	100	6500	600	23.5	37.5
20W	BCLAB 20W LED P	100	6500	1182	23.5	37.5
40W	BCLAB 40W WH LED	100	6500	1182	23.5	37.5

Options available -

- CCTS- Warm white, Neutral White

DAWN SMART

LED Batten

Illuminate intelligently, conserve effortlessly

Intelligent smart Extruded aluminium batten with PC diffuser suitable for surface mounting. This product has inbuilt occupancy sensor and suitable for applications like corridor, basements, parkings, etc



Superior & appealing aesthetics
Extruded aluminium housing fitted with Engg. Plastic end caps.



PIR Sensor for better ROI
Inbuilt occupancy sensor. Upto 10 mtr sensor coverage area. 30% light output in case of non-occupancy.



High Efficacy
LED populated on PCB comprising of LED's connected in series parallel.



Long Life
>50000 LED Burning Hours

>0.95
Power Factor

>80
CRI

<20%
THD (@240V AC)

Applications



Offices



Educational Facilities



Banks



Hospitals



Indoor Parking

Product Diagram

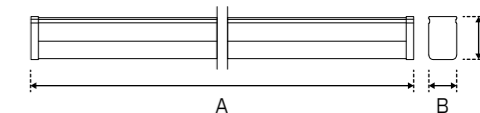

Specifications & Dimensions

Wattage	Cat ref	Efficacy (lm/W)	CCT (K)	Dimensions (mm)		
				A	B	C
20W	BCLAB 20W LED PS	100	6500	1182	23.5	37.5

DAWN PC

LED Batten

Bright Solutions, Bright Savings

PC Batten range of robust and high performance battens made up in thermally conductive material with high translucent and milky white diffuser for glare free illumination.



Superior & appealing aesthetics

Polycarbonate co-extrusion tube for LED light housing with engg-plastic end caps.



Better ROI

The diffuser is made of opal polycarbonate material with groove inside for PCB.



High Efficacy

upto 100 lm/W



Long Life

>50000 LED Burning Hours



>0.90
Power Factor



>80
CRI



<20%
THD (@240V AC)

Applications



Offices



Educational
Facilities



Banks



Hospitals



Indoor
Parking

Product Diagram

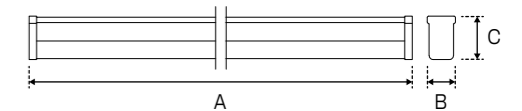

Specifications & Dimensions

Wattage	Cat ref	Efficacy (lm/W)	CCT (K)	Dimensions (mm)		
				A	B	C
5W	BCLSB 05 WH	100	6500	305	22	37
10W	BCLSB 10 WH	100	6500	602	22	37
18W	BCLSB 18 WH	100	6500	1135	22	37
20W	BCLSB 20 WH	100	6500	1135	22	37

Options available -

- CCTS- Warm white, Neutral White

BLITHE

LED Bed Light

Sleek and Elegant

Blithe is an overbed light that offers a sleek and elegant design to meet the needs of doctors, patients & caregivers as well. This multipurpose light incorporates the latest in LED technology to provide high-quality illumination while meeting the aesthetic requirements of the patient's room. The healthy lighting, simple design, solid-state performance, and durable construction are designed to take into consideration the varied challenges of the patient bed environment.



Elegant Design



Exceptional Visual Comfort



Individual control for Up-Down light and 3 Separate Switch Control



Ease of Installation

>0.90
Power Factor

>80
CRI

<10%
THD (UL+DL @240V AC)

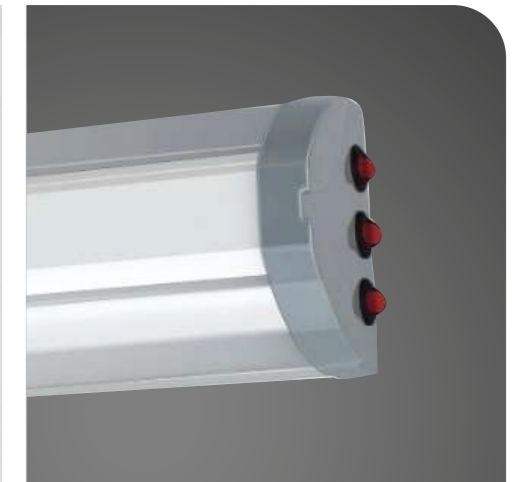

Applications



Offices



Assisted Living



Care Centre

Product Diagram

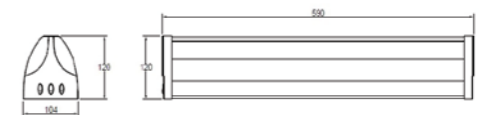

Specifications & Dimensions

Wattage	Cat ref	Efficacy (lm/W)	CCT (K)	Dimensions (mm)		
				A	B	C
28W (16WUL+9WDL+3WNL)	BLBDL 28W WH	100	5665K ±355K (DL) 3985 ± 275K (UL)	590	120	104



Electricals

27th Floor, One Unity Center (Erstwhile One International Center), Tower 4,
Senapati Bapat Marg, Prabhadevi (West), Mumbai - 400013 | Tel.: 022-2406 4400
E-mail: illumination@bajajelectricals.com | www.bajajelectricals.com

[f/BajajElecBiz](#) [✉/BajajElecBiz](#) [@/bajajelecbiz](#) [in/BajajElectricals](#)

Images of the products shown are for representation purpose only and the actual colour/size may vary.